

Customer/Wholesaler:	Date:	Job Name:	Model Specified:	Quantity:
Contractor:		Architect/Engineer:		

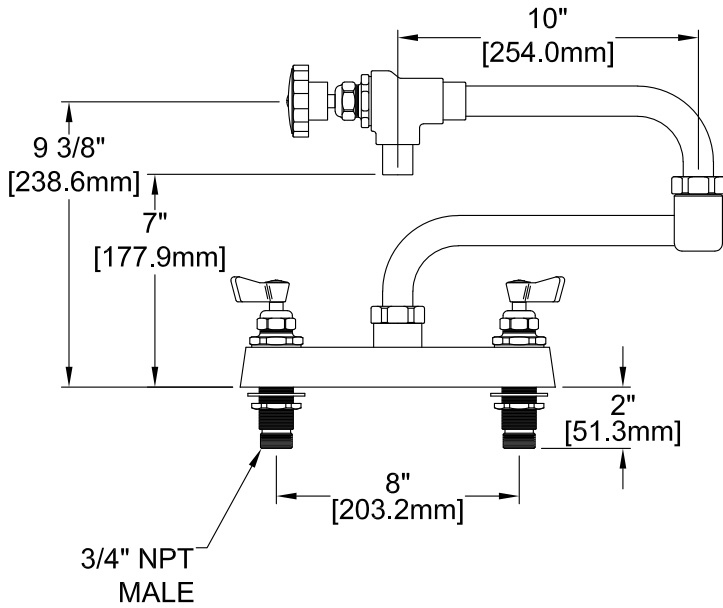

FOOTPRINT:

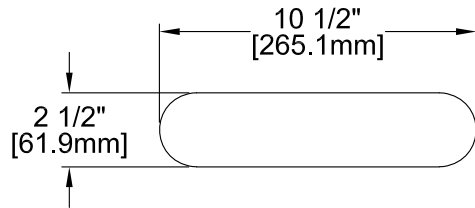

ROUGH-IN:

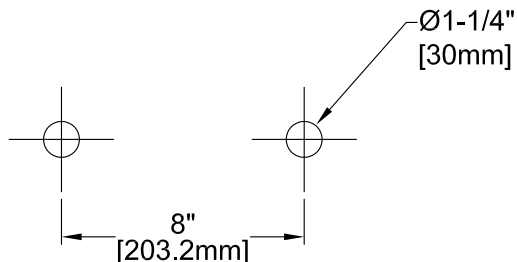

MODEL:

2275 3/4 FAUCET 8DLH 10CS10DJ

OPTIONS OR MODIFICATIONS:

OTHER _____

FEATURES:

- * 8" DECK MOUNT FAUCET
- * SWIVELING SEAT DISKS
- * HOT SIDE STEM - RIGHT HAND
- * COLD SIDE STEM - LEFT HAND
- * STAINLESS STEEL SEATS
- * STAINLESS STEEL SEAT SCREWS
- * STAINLESS STEEL HANDLE SCREWS

SYSTEM LIMITS

- * TEMP: 40°F MIN. TO 160°F MAX.
- * PRESSURE 200 PSI MAX. STATIC
- * 29 GPM AT 80 PSI (109.7 L/min @550 KPa)

SHIPPING WEIGHT

- * 10.00 LBS

PRODUCT COMPLIANCE:

- * ASME A112.18.1 / CSA B125.1
- * NSF 61 - Section 9
- * NSF 372 (Low Lead Content)

Replacement Parts for Deck Mount Faucets

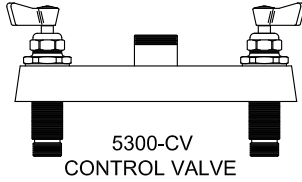

2000-7500
SCREW



2000-8000
RED BUTTON
AND
2000-8001
BLUE BUTTON

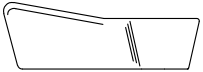

LEVER HANDLE

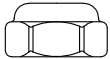

2000-3002
BIBB CAP



73657
DUCK GASKET



2000-5000
WASHER



5000-0012
RH CHECK STEM
REPAIR KIT
OR
5000-0013
LH CHECK STEM
REPAIR KIT



2000-6000
SPRING

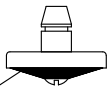

73453
RETAINER
ASSEMBLY

73550
SEAT WASHER

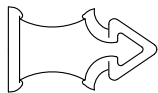

73521
LUBE

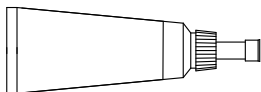

2992
PST

2000-0002
HANDLE LEVER KIT

5071
10" CONTROL
SWING
SPOUT

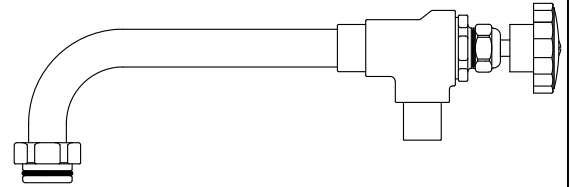

5000-0003
10" DJ SPOUT

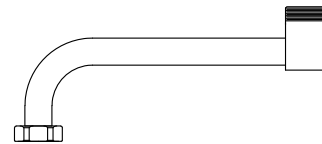

5000-0012
RH CHECK STEM
REPAIR KIT
OR
5000-0013
LH CHECK STEM
REPAIR KIT

73849
WASHER

6651-9000
3/4" LOCK NUT

73570
RIGHT HAND
STEM ADAPTER
OR
73569
LEFT HAND
STEM ADAPTER

